

Read this manual before operation

- The content include of electric connections and operating steps
- Read the manual to operate the systems

RDC6332G

Control System Manual

<https://www.ruidacontroller.com>



COPYRIGHT

■ All rights reserved. You may not reproduce, transmit, store in a retrieval system or adapt this publication, in any form or by any means, without the prior written permission of RuiDa, except as allowed under applicable copyright laws. We have identified words that we consider as trademarks. Neither the presence or absence of trademark identifications affects the legal status of any trademarks.

CERTIFICATION DECLARATION

CE

The product has been certified by the CE (Communate European) safety certification. It has passed the corresponding conformity assessment procedure and the manufacturer's declaration of conformity, in accordance with the relevant EU directive.

ROHS

This product has been certified by EU legislation (Restriction of Hazardous Substances) Safety certification; comply with relevant EU environmental regulations.

FCC

This product has been certified by the Federal Communications Commission for safety, Comply with us electronic safety regulations.

SAFETY INFORMATION

When using this system, please make sure the operation is correct and the usage is safe. Some signs or text will be used to remind you to pay attention to the dangerous matters and some important information.



Dangerous:

Indicates a serious danger. In the process of use, if the operation is improper or the way of use is wrong, it may cause serious injury or even death to the user. Please do not operate it easily until you have made sure that the operation method is correct and the way of use

is correct.



Warning:

Danger. In the process of use, if the operation is improper or the use is wrong, which may lead to the injury of the personnel, please do not operate the personnel and related personnel easily, until ensure the correct operation method and use method is correct before use.



Cautious:

Represents the potential risk of the product. In the process of use, if the use method is wrong or improper operation, it may cause damage to the product or some parts. Please do not use it until you have made sure that the operation method is correct and the usage

is correct.



Important:

Represents important information to be paid attention to during the use of the product. Please do not ignore this information, this information will provide effective operational help.



This sign indicates laser radiation, which is usually posted on products with laser output. Please be careful with laser and pay

attention to safety when using this kind of equipment.

Sign in、Devanning、Examine cargo

The product itself with plastic or metal shell, can protect the external electrical components from damage. The products are packed in foam bags and anti-static bags. If there is any external damage to the package, check the equipment and notify the carrier and carrier in writing of the damage.

Inportant:



After receiving the product, please check whether the outer package is intact, check whether the product is complete after unpacking and whether all parts are intact. If any damage is found, please contact ruida immediately.

Remove all cargo from package and keep packing material and wiring parts. Please take care of the safety of the goods when unpacking them. After taking out the goods, please check whether the parts are complete and intact. If any missing parts or damaged parts are found, please contact ruida technology immediately. Do not install or debug the equipment if any obvious damage is found.

Contents

Chapter 1 Overview.....	1
1.1 Briefing.....	2
1.2 Description of Controller Model.....	2
1.3 Comparison of Controller Performance.....	2
Chapter 2 Installation Size.....	4
2.1 Installation Size of MainBoard.....	5
2.2 Size of Panel.....	5
Chapter 3 Object Pictures and Interfaces.....	7
3.1 Object Pictures of MainBoard.....	8
3.2 Object Pictures of Panel.....	9
Chapter 4 Description of Interface Signal for MainBoard.....	10
4.1 Interface of Main Power Source CN1.....	12
4.2 Panel Power Interface CN0.....	12
4.3 Panel Signal-Cable Interface HDI.....	12
4.4 Reserved Interface HMI.....	12
4.5 Udisk Interface.....	12
4.6 USB Interface.....	13
4.7 Ethernet Interface.....	13
4.8 General Output Port CN2.....	13
4.9 3-axe Spacing and Special Input Interface CN3/CN4.....	14
4.10 X/Y/Z-axe Motion Drive Interface.....	15
4.11 Laser Power Control Interface CN6/CN7.....	15
4.12 Water Protect Input Interface CN5.....	16
Chapter 5 Examples of Laser Power Interface.....	17
5.1 Digital Laser Power Supply of Glass Tube.....	18
5.2 Analog Laser Power Supply of Glass Tube.....	18
5.3 RF CO2 Laser.....	19
Chapter 6 Examples of Driver Interface for Step-servo Motor.....	20
6.1 Overview.....	21
6.2 Valid Rising Edge for Pulse Signal.....	22
6.3 Valid Falling Edge for Pulse Signal.....	23
Chapter 7 Examples of IO-port Wiring.....	25
7.1 Input Port.....	26
7.2 Output Port.....	27
Chapter 8 Operating Instruction of Panel.....	28
8.1 Introduction to the Keys.....	29
8.1.1 Introduction to the whole panel.....	29
8.1.2 Introduction to the keys.....	29
8.2 Introduction to the interface functions.....	31
8.2.1 The screen of power on.....	31

8.2.2	The main interface.....	31
8.2.3	Speed settings.....	32
8.2.4	Max/Min power settings.....	33
8.2.5	Reset the axes.....	34
8.2.6	Set the layer parameters.....	34
8.3	Introduction to menus.....	35
8.3.1	Sys info.....	35
8.3.2	Sys config.....	36
8.3.3	Function sub menu.....	37
8.3.4	User para.....	39
8.3.5	Machine para.....	39
8.4	Introduction to file function.....	40
8.4.1	Memory file.....	41
8.4.2	Udisk file.....	41
8.5	Introduction to diagnoses function.....	42
8.6	Introduction to some alarm info.....	42
Chapter9	Manufacturer/User Parameters Explanation.....	43
9.1	Manufacturer Parameters.....	44
9.2	User Parameters.....	46

Section 1 Overview

CONTENTS:

- Briefing
- Description of
Controller Model
- Comparison of
Controller Performance

1.1 Briefing

RDC6332G system is a new generation system for control of laser engraving and cutting, which is developed by RD Co., Ltd. In addition to high hardware stability, high voltage or static electricity rejection, and friendly 320*240 TFT man-machine display based on Linux. This system is provided with stronger software function including perfect 3-axle motion control function, large-capacity file storage, two-channel adjustable digits, analog laser power control interface, USB driver of stronger compatibility, multi-channel general/special IO control, and realtime clock and battery integrated for hardware encrypt, and, this system can communicate with PC by USB2.0 or Ethernet.

1.2 Description of Controller Model

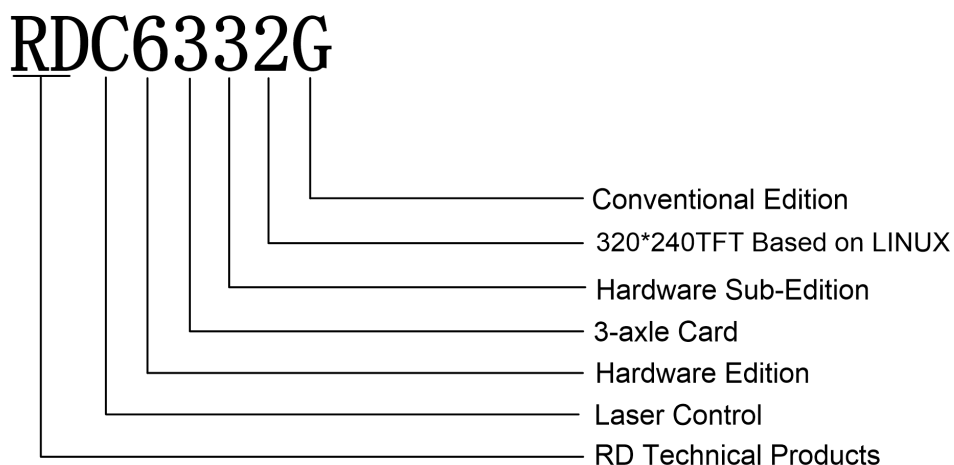

1.3 Comparison of Controller Performance

		RDL310	RDL420	RDC6332G
Power Feature		Two-way 5V, independent	One-way 5V, one-way 24V, independent	Only one-way 24V (compatible with 36V for power supply, but not recommended)
Laser Port Feature		Only one-way digital control port	One-way digit and one-way analog	Two-way digits and two-way analog port, settable independently and non-interacted
USB Feature	Copying Speed	Slow	Common	Very Quick
	Compatibility	Support a few USB disks	Support USB disks with small capacity	Support all USB disks with different capacities
Memory Feature	Capacity	32M	64M	256M
	Fault Tolerance	Poor	Common	Capable of checking defective track and formatting and good in fault tolerance
General	Input Port	Nil	Two ways	4 ways (two for general, two for

IO Feature				specialties)
	Output Port	Nil	1-way (low current, additional drive is needed)	4-ways (500mA high current for each, OC output, two for general, two for specialties)
Software Feature	Power-off restart for Engraving	NO	YES	YES
	Multi-origin Logics	NO	NO	YES
	Parameter Backup Logics	NO	NO	YES
	Work time Preview	NO	NO	YES (the work time accurate to 1ms)
	Online Updata Mainboard Program	NO	NO	YES
Display Feature	Online Modification Laser Power/Speed	NO	YES	YES
	Offline Modification Layer parameters	NO	NO	YES
	Online Updata Startup Display	NO	NO	YES
	File dynamic/static preview	NO	NO	YES
	Modification Factory/User's para on display	NO	NO	YES
	Display type	128*64, dot display	128*64, dot display	320*240 TFT display
Motion-axle Feature	Soft Spacing	YES	YES	YES
	Hard Spacing	NO	NO	YES
	Z-axle Linkage	NO	NO	YES
	Feeding Feature	Null	Single direction	Single/double direction for option
	Power-on Resetting	Fixed	Fixed	Configurable for each axes
	Key Speed	Fixed	Fixed	Configurable
	Axles	3	4	3 (Z axes is configurable to flat or feedin axes)
Encryption Feature	Null	Encryption based on the PC time	Realtime clock and battery integrated for hardware encryption	
Communicate Mode		USB2.0	USB2.0	10/100MHZ Ethernet or USB2.0

Section 2 Installation Size

CONTENTS:

- Installation Size of
MainBoard
- Size of Panel

2.1 Installation Size of MainBoard

The unit of all sizes is millimeter (mm) and the size accurate to 0.1mm.

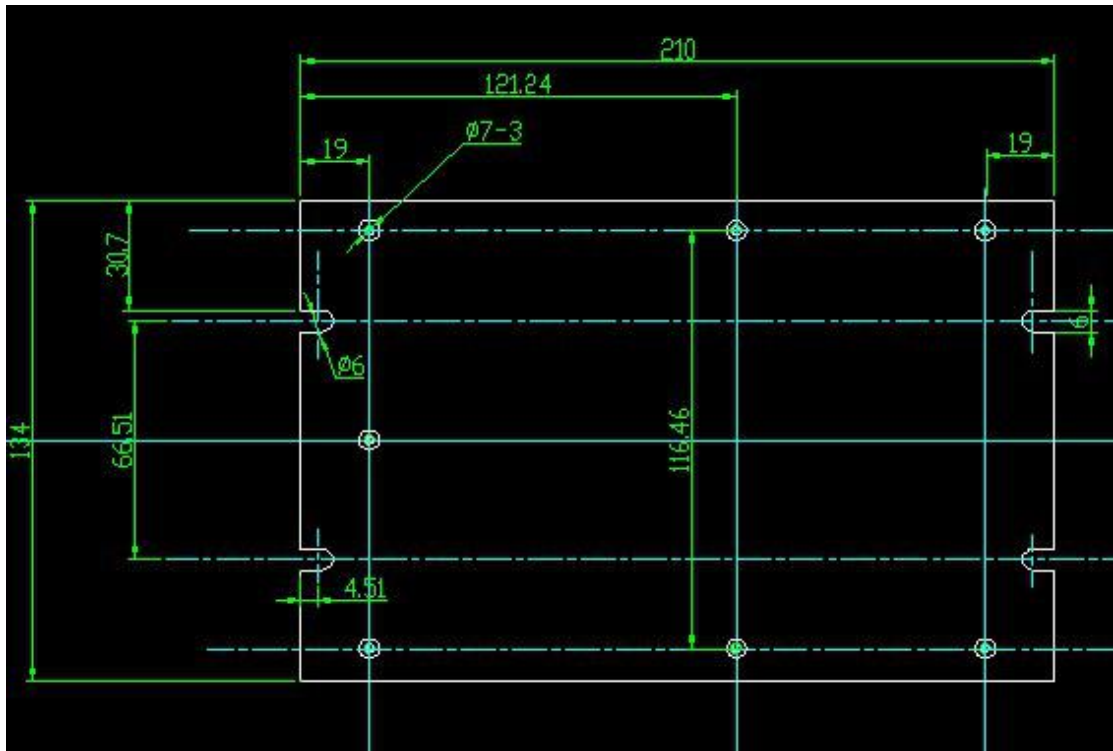

Figure: 2.1-1

2.2 Size of Panel

The unit of all sizes is millimeter (mm) and the size accurate to 0.1mm.

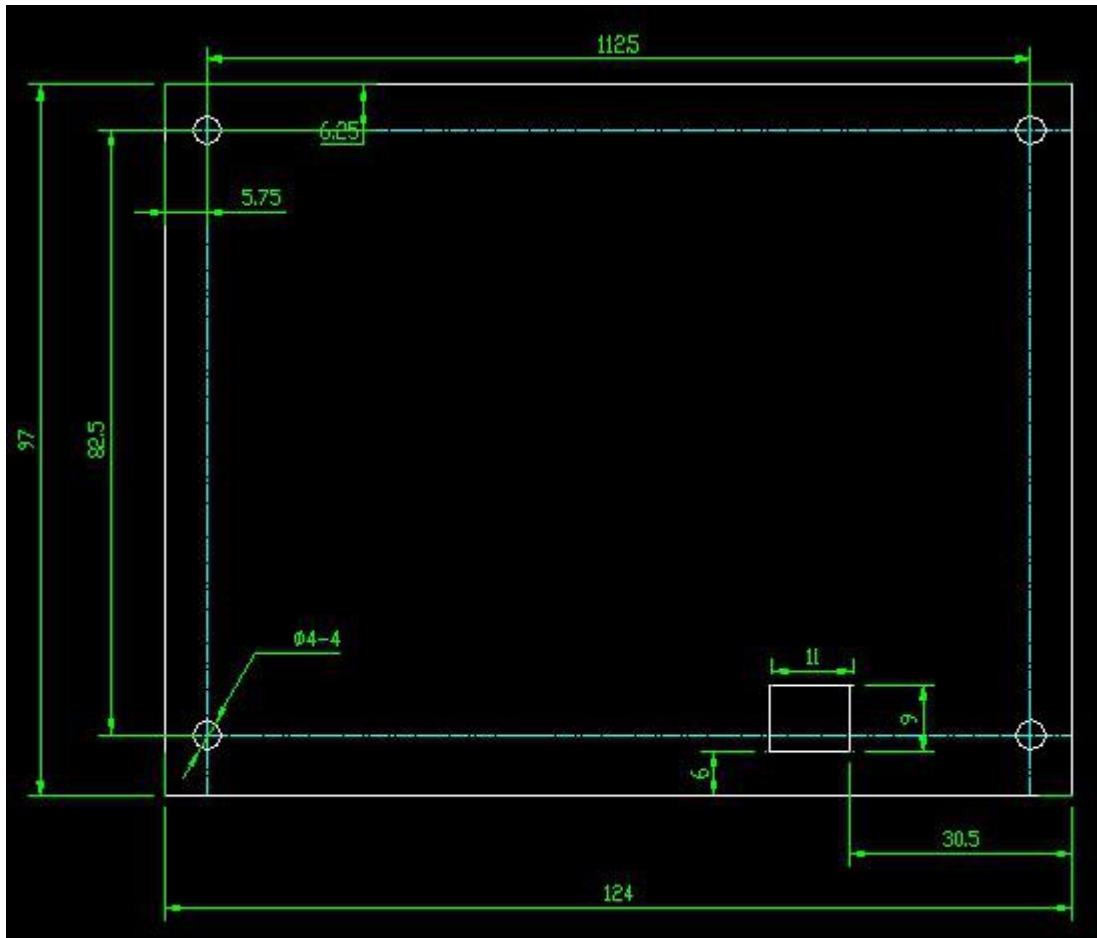

Figure: 2.2-1

Section3 Object Pictures and Interfaces

CONTENTS:

- Object Pictures of
MainBoard
- Object Pictures of
Panel

3.1 Object Pictures of MainBoard

For more detailed pin description, see the Chapter 4: Description of Interface Signal for MainBoard.

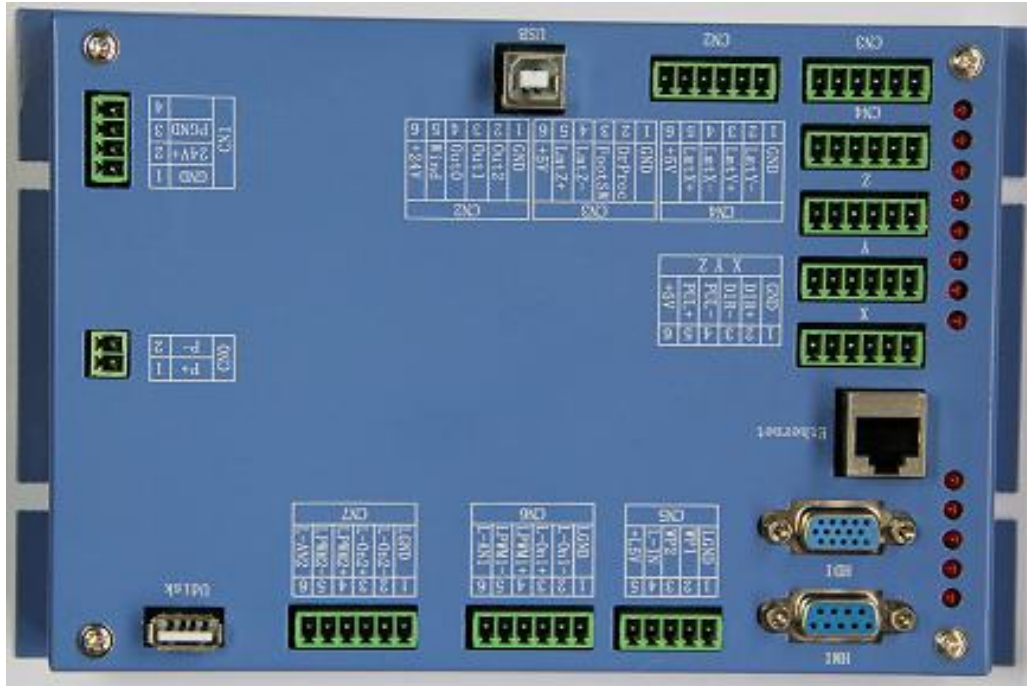

Figure: 3.1-1 Object Picture of MainBoard

3.2 Object Pictures of Panel

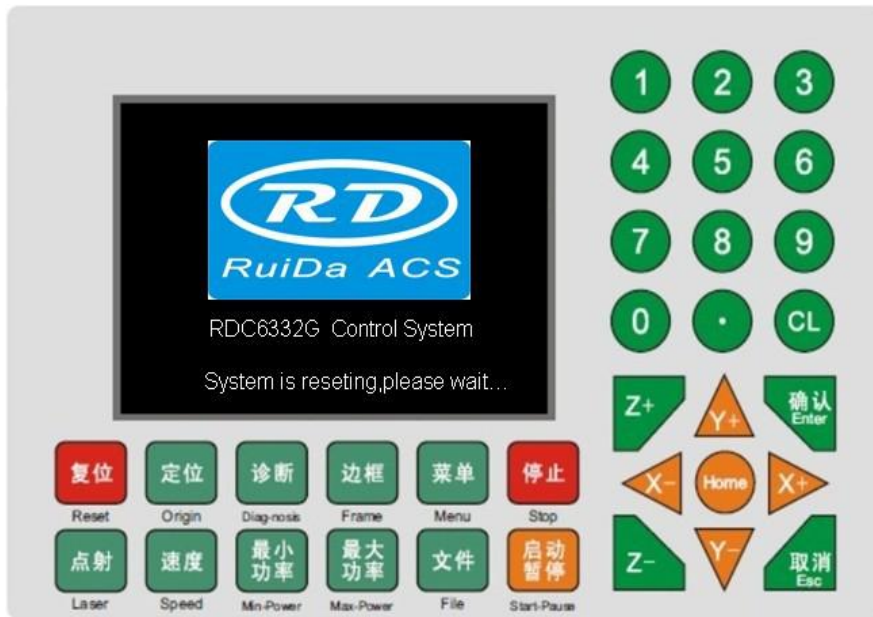

Figure: 3.2-1 Object Picture of Panel

Section 4 Description of Interface Signal for MainBoard

CONTENTS:

- Interface of Main Power Source CN1
- Panel Power Interface CN0
- Panel Signal-Cable Interface HDI
- Reserved Interface HMI
- Udisk Interface
- USB Interface
- Ethernet Interface

- **General Output Port
CN2**
- **3-axle Spacing and
Special Input
Interface CN3/CN4**
- **X/Y/Z-axle Motion
Drive Interface**
- **Laser Power Control
Interface CN6/CN7**
- **Water Protect Input
Interface CN5**

4.1 Interface of Main Power Source CN1

No.	Symbols	Definitions
1	OGND	24V power ground (input)
2	+24V	24V power positive (input)
3	NC	No used
4	NC	No used

 Caution	<p>This control system employs single 24 power supply. For a certain margin, it is suggested to select 24V/2A power. Besides, this system is compatible with 36V power, that is to say, the 36V power of Motion driver can directly be connected to this main power port of this system, but generally it is not suggested to do so.</p>
---	--

4.2 Panel Power Interface CN0

No.	Symbols	Definitions
1	P+	5V power positive (output) (Only power for pannel)
2	P-	5V power ground (output)

 Caution	<p>CN0 only power for 320*240 TFT display, and can't for other use. Mainboard P+ connect to pannel P+, Mainboard P- connect to pannel P-.</p>
---	---

4.3 Panel Signal-Cable Interface HDI

HDI is a normative DB15 interface, using the DB15 cable provided by factory to connect the mainboard and the panel.

4.4 Reserved Interface HMI

HMI is a factory interface whose function is reserved to user.

4.5 Udisk Interface

Udisk interface is a USB-AM, by this interface, the mainboard can read/write all kinds of

U-discs.

4.6 USB Interface

USB interface is a USB-BM, using this interface, the mainboard can communicate with PC by USB2.0.

4.7 Ethernet Interface

Using this interface, the mainboard can communicate with PC by 10/100MHZ ethernet.

 Caution	Pin to Pin ethernet parallel line is recommended.
--	---

4.8 General Output Port CN2

Definition of general output port (6Pin, 3.81mm space)

Pin	Symbols	Definitions
1	OGND	External power ground (output)
2	Out4	General output 4, with the function reserved.
3	Out3	General output 3, with the function reserved.
4	Out2	General output 2, and the signal port of operating status. If this port is externally connected with the relay, the relay coil is broken over when it works; no influence is produced when it suspends working. When its work ends or is stopped manually, the relay coil will be cut off.
5	Wind	General output 1. When the blower control is enabled, this port will output the control signal of the blower, otherwise it will output other special control signals. When the blower is connected and its control enabled, the blower switch can be set separately on each layer. If the relay is connected externally, the relay coil will be broken over when the blower is on; the relay coil will be cut off when the blower is off.
6	O 24V	External power output (If the interface of main power source is powered with 24V power supply, this pin should be 24V; if it is powered with 36 V power supply, this pin should be 36V.)

 Prompt	All outputs are isolated through the optocoupler, and 500mA current for each, OC gate output, each can directly drive the 6V/24V relay.
---	---

4.9 3-axle Spacing and Special Input Interface CN3/CN4

Z-axle spacing and special input interface CN3 (6Pin, 3.81mm space)

No.	Symbols	Definitions
1	OGND	External power ground (output)
2	DrProc	Input from protective port. If the machine needs to be protected in the special state (such as door open protection), the protective signal can be inputted from this pin. This pin can be enabled and prohibited. This signal is not inquired by the mainboard if this pin is prohibited; if this pin is enabled, when the input is high-leveled or this input port is suspended, the machine will be protected, the work suspended and the laser closed.
3	FootSW	Input port of foot switch. The connection method is: when the pedal is stepped down, the low-level signal will be inputted to this port; when the pedal is released, the port will be disconnected or the high-level signal can be inputted to this port; when the stepped-down pedal is held for not less than 100 ms, if the machine lies idle, it can be started for work; if the machine is in the working state, the work will be suspended; of the machine is in the suspension, the work will be restarted, that is to say, the function of the pedal switch is the same as that of the "Start/Pause" key. If the interval time to the first stepping-down of the pedal should be less than 1.5 seconds when the pedal is stepped down once again, the second stepping-down of the pedal will be considered invalid by the mainboard.
4	LmtZ-	The spacing from axle Z- and Z to 0 coordinate
5	LmtZ+	The spacing from axle Z- and Z to max. coordinate
6	O 5V	External power source + 5V (output)

X/Y-axle spacing interface CN4 (6Pin, 3.81mm space)

No.	Symbols	Definitions
1	OGND	External power ground (output)
2	LmtY-	The spacing from axle Y- and Y to 0 coordinate
3	LmtY+	The spacing from axle Y+ and Y to max. coordinate
4	LmtX-	The spacing from axle X- and X to 0 coordinate
5	LmtX+	The spacing from axle X+ and X to max. coordinate

6	O 5V	External power source + 5V (output)
---	------	-------------------------------------

The spacing polarity is optional, that is to say, when the motion axle reaches the spacing position, it will trigger a low-level signal so as to make the corresponding LED (under the cover) light; when the motion axle leaves the spacing position, it will trigger a high-level signal or disconnect the spacing signal so as to make the spacing indicator go out, but when it leaves the spacing, the corresponding indicator will light and the spacing polarity become positive. The mistaken setting of spacing polarity will result that the spacing can't be detected when the system is reset so as to lead to the collision of axles.

4.10 X/Y/Z-axle Motion Drive Interface

The interfaces of the above three motion axles are the same (6Pin, 3.81mm space). The Axle-X interface is exemplified.

Pin	Symbols	Definitions
1	GND	Kernel power ground (output, only used for common cathode connection of driver)
2	xDir+	Differential plus end of directional signal
3	xDir-	Differential minus end of directional signal
4	xPulse-	Differential minus end of pulse signal (when the common anode connection is used and the pulse rising edge valid, input will start from this pin.)
5	xPulse+	Differential plus end of pulse signal (when the common anode connection is used and the pulse falling edge valid, input will start from this pin.)
6	+5V	Kernel 5V power positive (output, only used for common anode connection of driver)

The polarity of directional signal for driver pulse signal can be set. Where a certain axle is reset, it will move to the opposite direction of machine origin, which means the polarity of directional signal for this axle is not correct. In such a case, the connection between this axle and the motor driver can be broken first (otherwise the mainboard can not be detected to the spacing so as to lead to the collision of this axle), and then such a polarity can be corrected after this axle is reset completely. Upon the correction, the reset key can be pressed against to reset the mainboard.

4.11 Laser Power Control Interface CN6/CN7

This control system has two independent and adjustable digital/analog laser power control interfaces. Signals of the two interfaces are similar and the first digital interface (CN6) is hereby exemplified (6Pin, 3.81mm space):

Pin	Symbols	Definitions
-----	---------	-------------

1	LGND	Laser power 5V ground (output)
2	L-On1-	Laser-enabled control interface 1. When the laser is the RF laser, this pin will not be used; 2. When the laser is a glass tube, if the used laser is outputted in the low-level form, this pin will be connected with the laser power enable end and used to control the ON/Off of laser.
3	L-On1+	Laser-enabled control interface 1. When the laser is the RF laser, this pin will not be used; 2. When the laser is a glass tube, if the used laser is outputted in the high-level form, this pin will be connected with the laser power enable end and used to control the ON/Off of laser.
4	LPWM1+	Power control interface of laser/laser tube 1. When the laser is the RF laser, this pin will not be used; 2. When the laser is a glass tube and the laser power PWM end is high-leveled, this pin will be connected with the laser power PWM end and used to control the power of the laser.
5	LPWM1-	Power control interface of laser/laser tube 1. When the laser is the RF laser, this pin will be connected with the laser RF-PWM end; 2. When the laser is a glass tube and the laser power PWM end is low-leveled, this pin will be connected with the laser power PWM end and used to control the power of the laser.
6	L-AN1	Analog voltage 1 and connected with the power control end of the first analog laser power source

Prompt

Please make corrective choice of laser type. After the option for laser type is modified, the mainboard should be reset so that the modification can be effected after resetting.

4.12 Water Protect Input Interface CN5

Water protect input interface CN5 (5Pin, 3.81mm space):

Pin	Symbols	Definitions
1	LGND	Laser power 5V ground (output)
2	WP1	The input port of water protector for the first laser power source. When the water protector 1 is enabled, the mainboard will detect the input port of water protector 1. If this port is of low level, it will be deemed normal; if this port is of high level, the mainboard will forcibly close the laser to suspend the work in progress and the system will warn. If the water protector 1 is not enabled, the mainboard will not detect the input port of water protector 1 and the user not connect the water protector 1.
3	WP2	The input port of water protector for the second laser power source. When the water protector 2 is enabled, the mainboard will detect the input port of water protector 2. If this port is of low level, it will be deemed normal; if this port is of high level, the mainboard will forcibly close the laser to suspend the work in progress and the system will warn. If the water protector 2 is not enabled, the mainboard will not detect the input port of water protector 2 and the user not connect the water protector 2.
4	L-IN3	General input with the function reserved.
5	L5V	Laser power 5V positive (output)

Section 5 Examples of Laser Power Interface

CONTENTS:

- Digital Laser Power
 - Supply of Glass Tube
- Analog Laser Power
 - Supply of Glass Tube
- RF CO2 Laser

5.1 Digital Laser Power Supply of Glass Tube

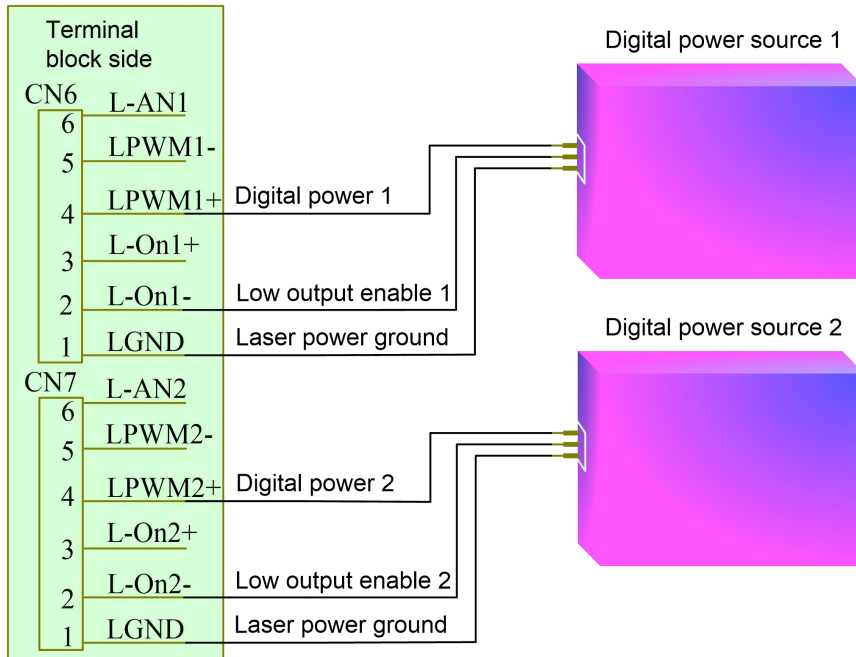

5.2 Analog Laser Power Supply of Glass Tube

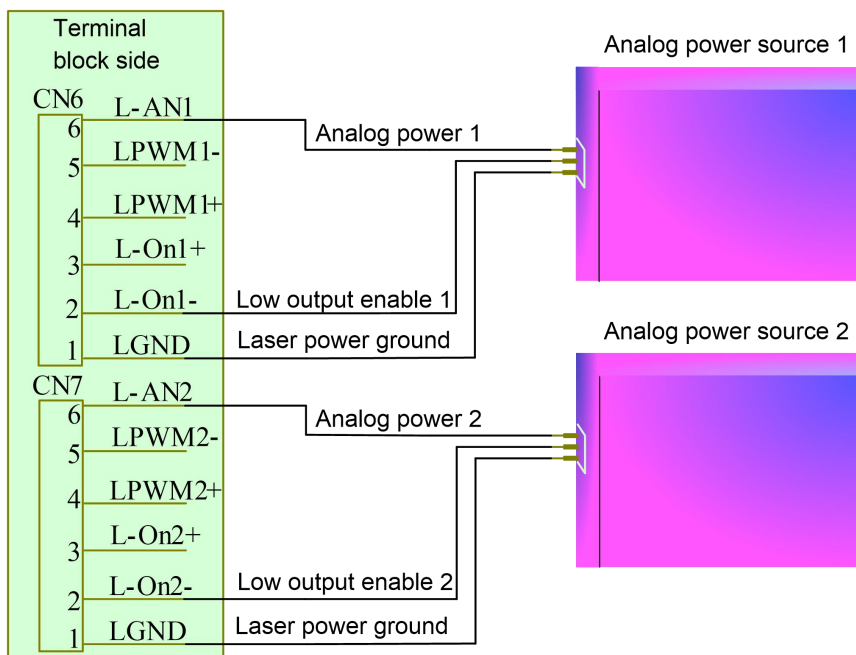

5.3 RF CO2 Laser

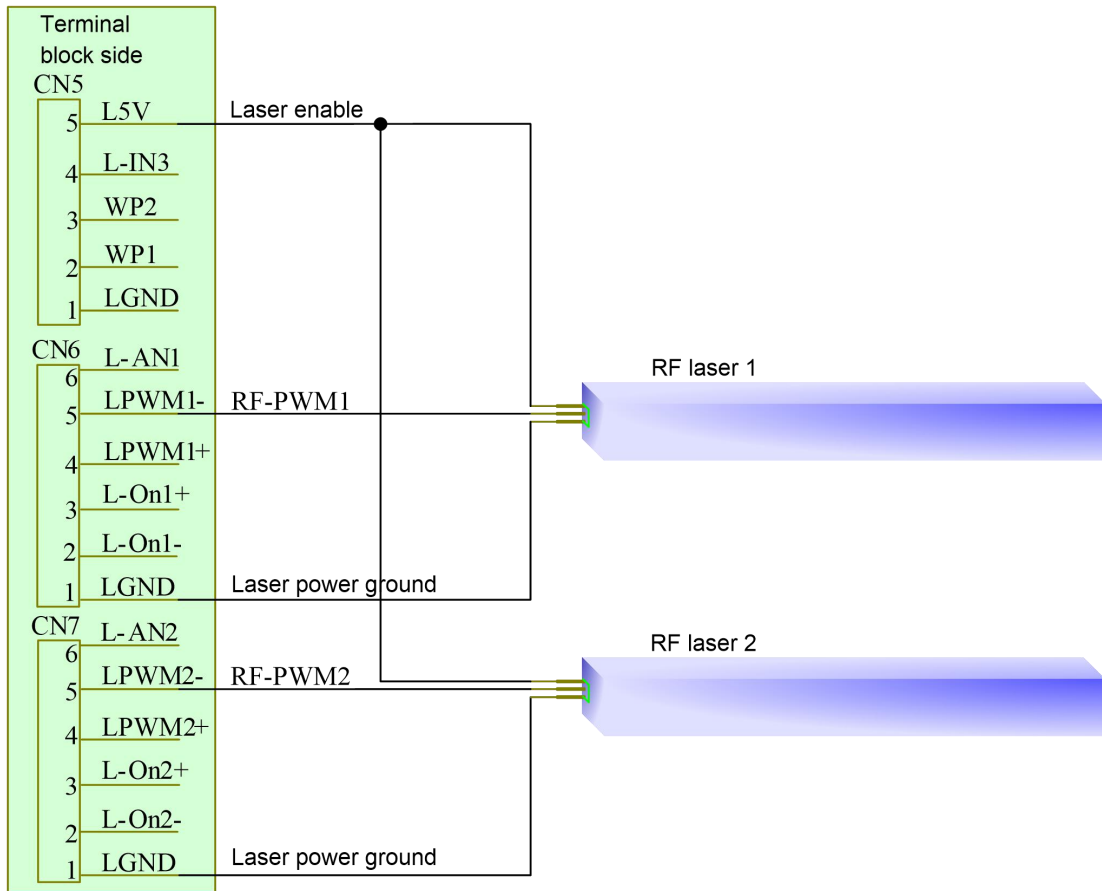

Section 6 Examples of Driver Interface for Step-servo Motor

CONTENTS:

- Overview
- Valid Rising Edge for Pulse Signal
- Valid Falling Edge for Pulse Signal

6.1 Overview

The input signal end of step-servo motor driver employs the light-coupled isolation technology. For the step-by-step impulse signal, some isolate the side OC diode from cutoff to conduction (e.g. the valid falling edge of pulse signal inputted from the diode minus end) and some do so from conduction to cutoff (e.g. the valid rising edge of pulse signal inputted from the diode minus end). When it is indicated whether the pulse signal of motor driver is the valid rising edge or the valid falling edge, it will be subject to the pulse signal inputted from the minus end of side OC diode.

Some input signals of motor driver are independent and some are internally of common anode, so some have 4 external leading-out wires and some 3 wires (only the pulse and directional signals are counted) as shown in Figure 10 and 11. Meanwhile, the input signal can generally be compatible with different voltage classes. If it is higher than the 5V signal, it is necessary to connect the current-limiting resistance externally. The interface signals of motor driver for RD mainboard are the 5V signals that should directly be abutted with the corresponding terminals to the driver.

The interface pulse end of each motor driver for RD mainboard can provide such two signals as the rising-edge walk and falling-edge travel. The improper use of the pulse-end signal may give rise to the lost steps, even back-run and finally dislocation of processed figure when the motor steers. In addition, this mainboard provide two directional signals not restrict in requirements. Either signal can be connected with the directional signal end of driver in the common-anode mode. Both directional signal ends can also be connected with the driver in the differential mode. In such a case, plus and minus can be exchanged at random. The result of exchange is that the rotating direction of motor is different from the actually desired direction. At this time the polarity of directional signal for the motor can be modified on the PC software. In this section is exemplified the driver of step-servo motor popular in the market. In addition to that the correct wiring scheme of this mainboard and motor driver is provided, it is recommended to use the common-anode connection in all wiring schemes.

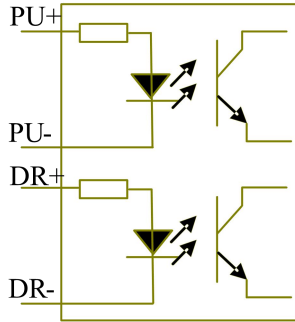

Figure: 6.1-1 Four Inputs, Independent Input Signal of Driver

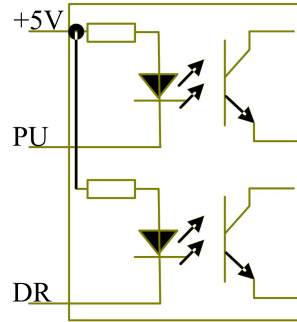

Figure: 6.1-2 Three Inputs, Common-anode Input Signal of Driver

6.2 Valid Rising Edge for Pulse Signal

The driver of the step-servo motor produced by Leadshine Technology Co., Ltd. is on the valid rising edge. Some of its products can support the mode of valid rising/falling edge. When these products are delivered out of the factory, they are all set at the valid rising edge; if the user changes the ex-factory setting into the valid pulse falling edge, Section 6.3 can be referred to for the wiring method. For the typical models such as M860 and 3MD560, Figure 6.2-1 and 6.2-2 show the wiring scheme of RD mainboard and Leadshine driver.

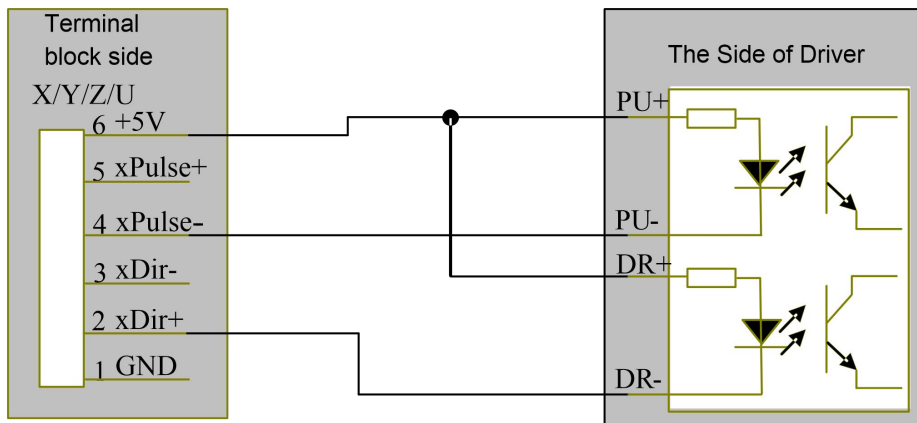

Figure: 6.2-1 Four Inputs, Valid Rising Edge and Common Anode

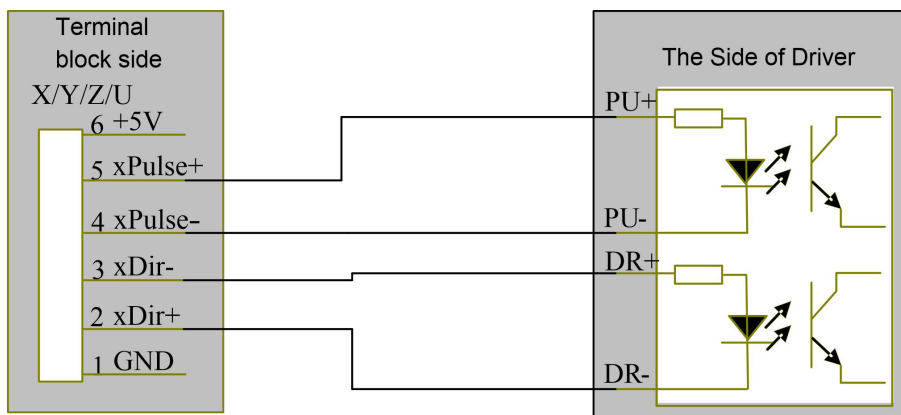

Figure: 6.2-2 Four Inputs, Valid Rising Edge and Differential

6.3 Valid Falling Edge for Pulse Signal

The driver pulse ends of drivers for step-servo motors presently produced by most of manufacturers are of valid falling edge. These companies include BERGER LAHR, Beijing HollySyn Motor Technology Co., Ltd., Shenzhen YAKO Automation Technology Co., Ltd., Shenzhen Baishan Mechatronics Co., Ltd., Beijing Jektechnology Co., Ltd. and the like. The input signals for some motor drivers are independent and some of common anode.

(1). The drivers with independent input signals include D921 and WD3-00X from BERGER LAHR, YKA3722MA from Shenzhen YAKO Automation Technology Co., Ltd., JK-2HB402M from Beijing Jektechnology Co., Ltd., Q2HB44MC(D) and Q3HB64MA from Shenzhen Baishan Mechatronics Co., Ltd.

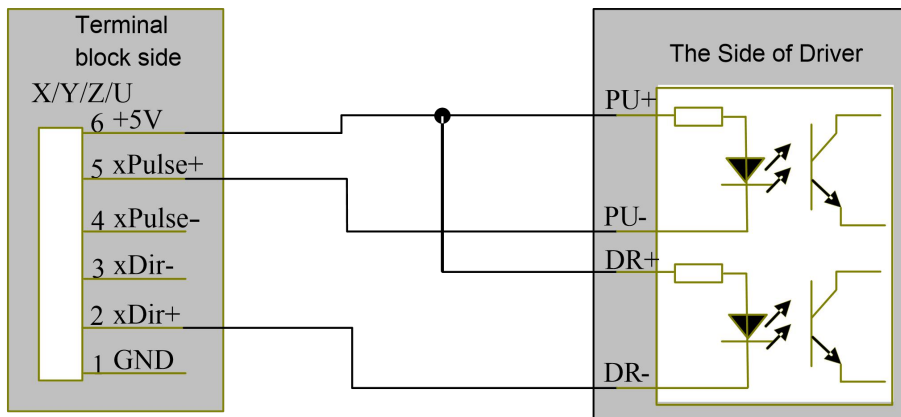

Figure: 6.3-1 Four Inputs, Valid Falling Edge and Common Anode

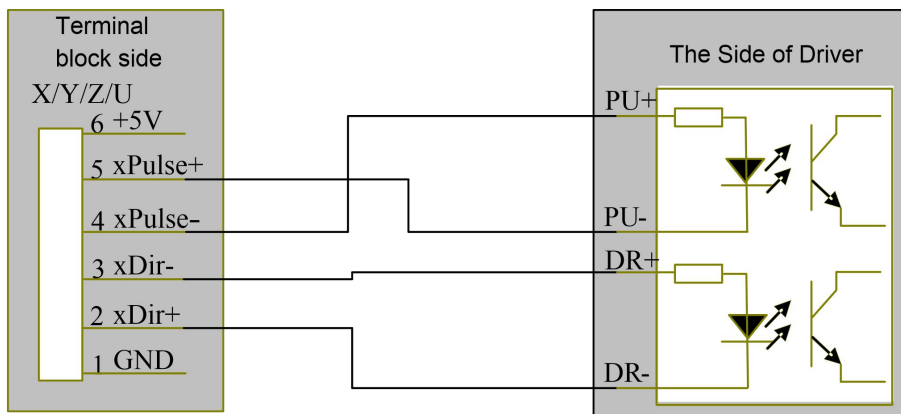

Figure: 6.3-2 Four Inputs, Valid Falling Edge and Differential Connection

(2). The drivers with common-anode input signals include YKA2304ME from Shenzhen YAKO Automation Technology Co., Ltd., Q2HB34MB and Q2HB44MA(B) from Shenzhen Baishan Mechatronics Co., Ltd.

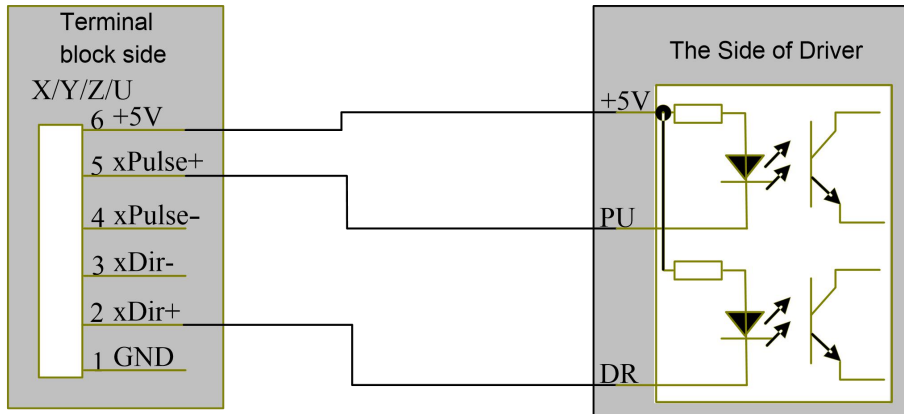



Figure: 6.3-3 Three Inputs, Valid Falling Edge and Common Anode

Section 7 Examples of IO-port Wiring

CONTENTS:

-  Input Port
-  Output Port

7.1 Input Port

The input connection at X/Y minus spacing is exemplified.

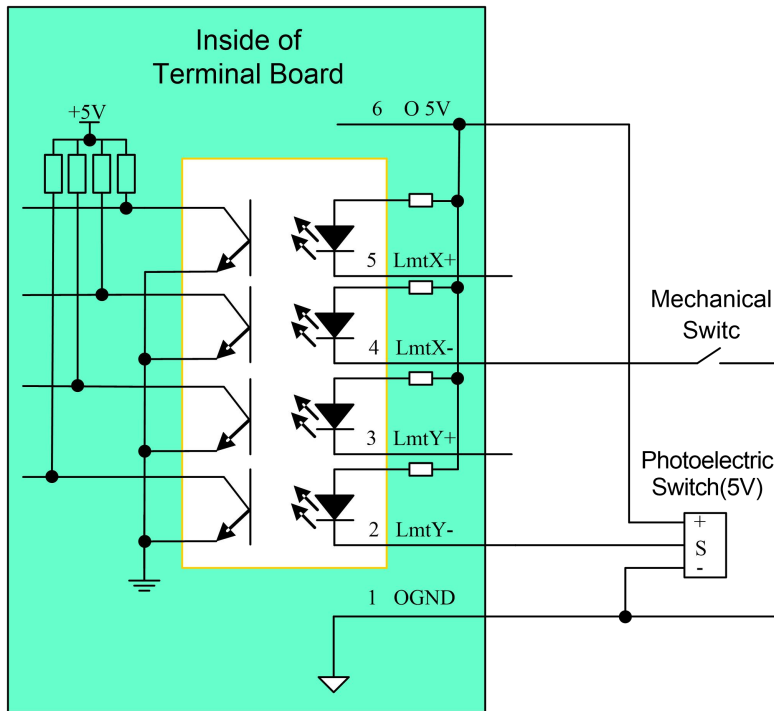

Figure: 7.1-1 Example of Input-port Connection

7.2 Output Port

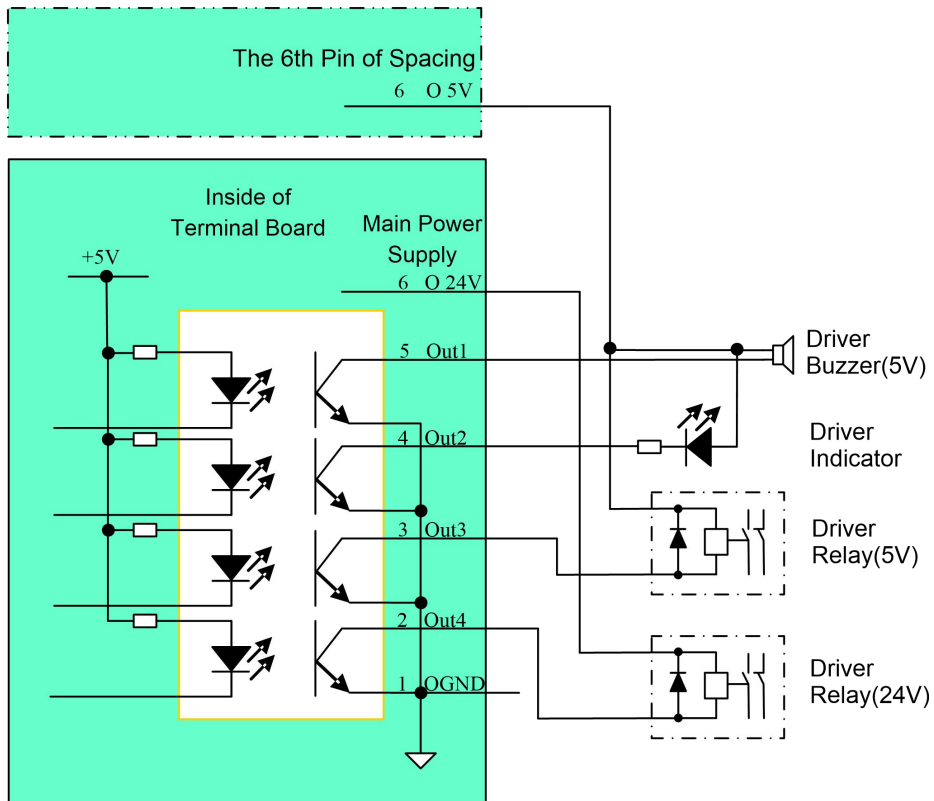

Figure: 7.2-1 Example of Output-port Connection

Section 8 Operating Instruction of Panel

CONTENTS:



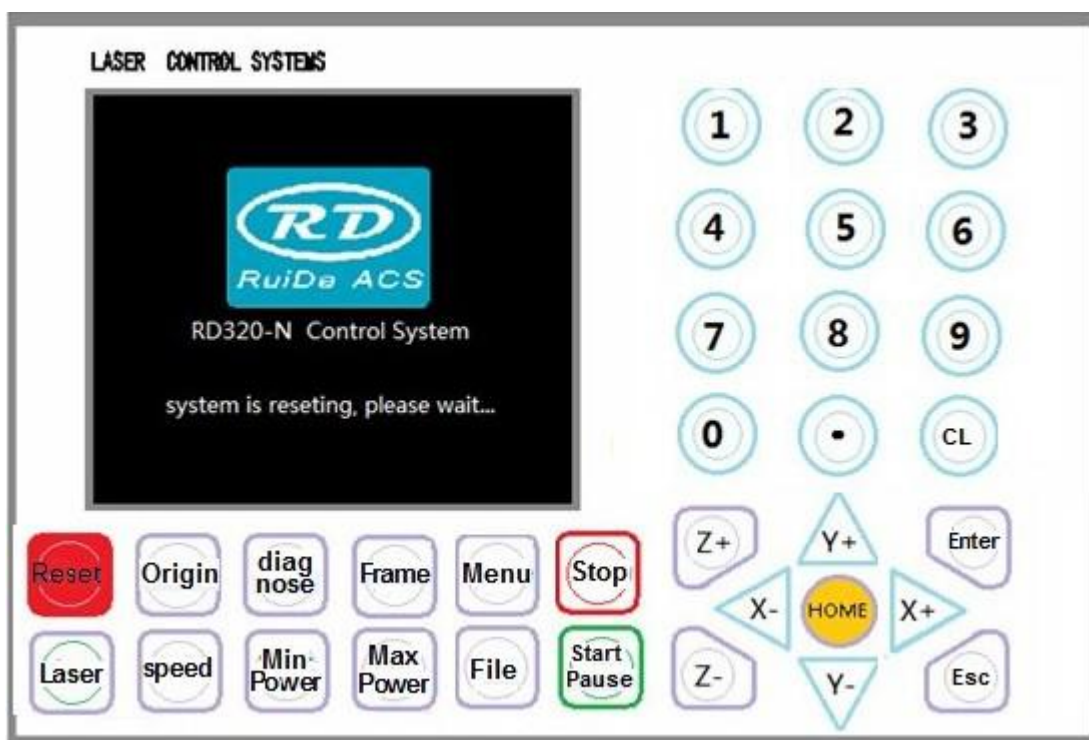

- Introduction to the Keys
- Introduction to the interface
Functions
- Introduction to file function
- Introduction to diagnoses
Function
- Introduction to some
alarm info

8.1 Introduction to the Keys

8.1.1 Introduction to the whole panel



8.1.2 Introduction to the keys

- “Reset” Key  :Reset the whole system;
- “Origin” Key  :Set the relative origin;
- “Laser” Key  :Let the Laser to splash;
- “Frame” Key  :To track by the current file’s frame;
- “File” Key  :The management of the memory and U disc files;

- “Speed” Key  :Set the speed of the current running layer, or set the direction keys’ move speed;

- “Max Power” Key  :Set the max laser power of the current running layer, or set the power of “Laser” Key;

- “Min Power” Key  :Set the min laser power of the current running layer,

- “Stop” Key  :To stop the work;

- “Start/Pause” Key  :To start or pause the work;

- “X+/-” Keys  :To move the X axes or the left/right cursor;

- “Y+/-” Keys  :To move the Y axes or the up/down cursor;

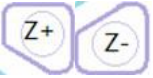
- “Z+/-” Keys  :To move the Z axes or change the parameter pages;

- “HOME” Key  :Let the selected axes go back to absolute origin;

- “Menu” Key  :Set the system parameter;

- “Diagnose” Key  :Diagnose the system, such as the limiter status, water protect etc.;

- “Esc” Key  :To stop work, or to exit to some munu.;

- “Enter” Key  : Validate the change;

- “Numeral” Keys  :To set the parameters;

- “Dot” Key  :To set the parameters;

- “CL” Key  :To cancel the last settings;

8.2 Introduction to the interface functions

8.2.1 The screen of power on

When the system is powered on, the screen will show as below:



Figure:

This power on screen can be changed by user. If the user-defined graph is downloaded by the PC software, when restart the system, it will show the new graph.

8.2.2 The main interface

When the system finished searching the machine origin, the screen will show as below:



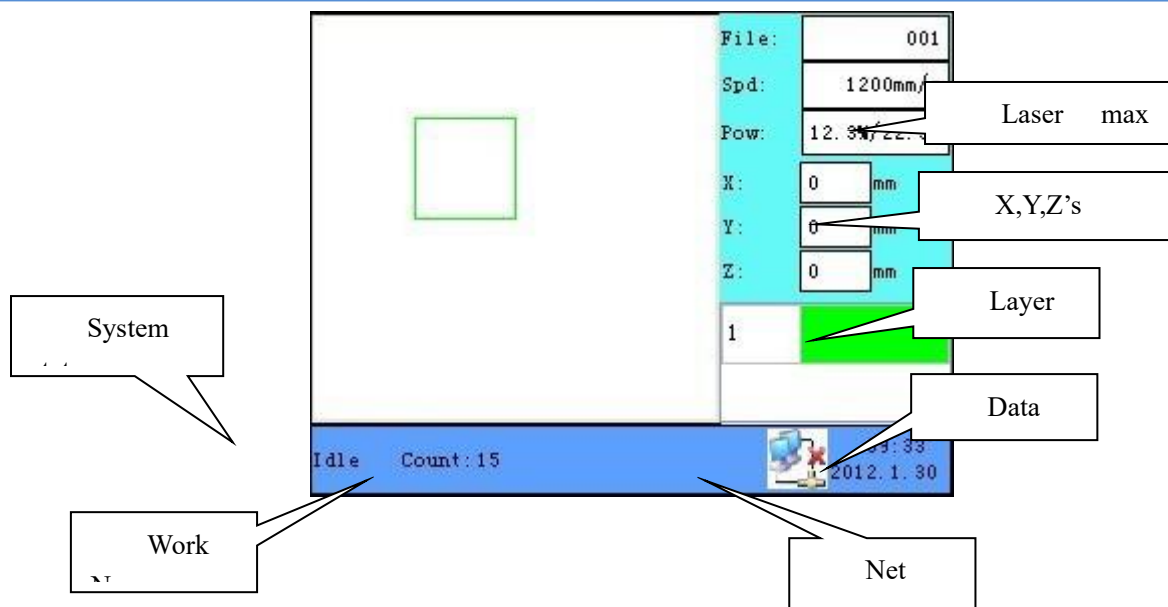

Figure:

Graph Preview Area: To display the whole file's track, and display the running track.

System status: To display the current status of the machine, such as Idle, Run, Pause, Finish, etc..

Work No.:To accumulate the work number of the current file.

Net status:To display the connecting status of the ethernet.

Data:To display the system time.

Layer Info.:To display the layers' information of the current file, such as max or min power, speed etc.. When system is idle, dclick the layer, then users can change the layer's parameters and the changing would be saved.

XYZ's coordinate:To display the coordinate of XYZ axes, and the size accurate to 0.1mm.

Laser max power:When system is idle, to display the "Laser" key's power, when system is running, to display the max laser power of the running layer.

Work speed: When system is idle, to display the "Up/Down" or "Left/Right" key's speed, when system is running, to display the running speed of the current layer.

File No.:To display the current selected file's number.

8.2.3 Speed settings

Push the "Speed" key when the screen is on the main interface, it will show as below:



Figure:

Push the “X+/-“ Keys to move the cursor in the numeral area, then push the “CL” key to delete the old value, push the “Numeral” Keys to set the new value, then push the “Enter” key to save the change, push the “Esc” key to invalidate the change.

8.2.4 Max/Min power settings

Push the “Max Power” or the “Min Power” keys when the screen is on the main interface, it will show as below:

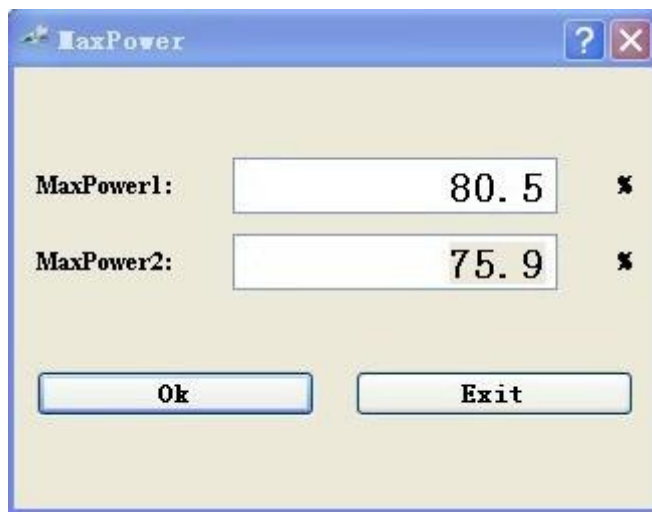

Figure:

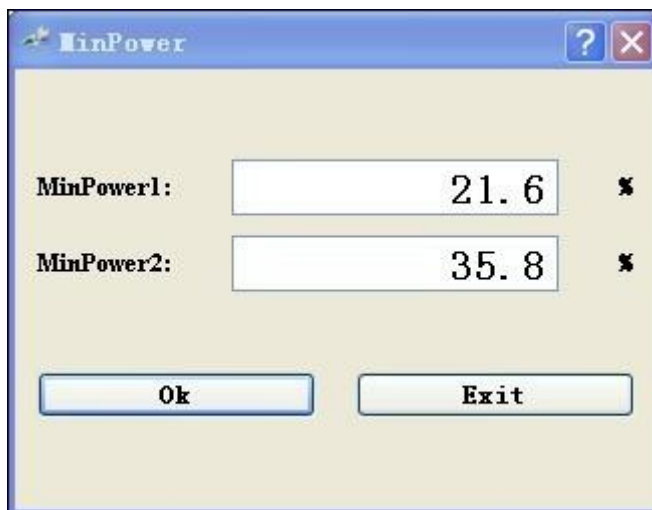

Figure:

The way of changing the parameters is all the same as changing speed.

8.2.5 Reset the axes

Push the “Home” key when the screen is on the main interface, it will show as below:



Figure:

Push the “X+/-“ Keys to move the cursor to one of the entry, then push “Enter” key to restart the selected axes, the screen will show some information when resetting.

8.2.6 Set the layer parameters

After selecting a file to preview on the main interface, user can push “Enter” key to let the cursor move to the first layer, then “Z+/-“ Keys can be pushed to select the intent layer, on that time, user can push “Enter” key to check the selected layer’s parameters, show as below:



Figure:

User can push “Z+/-” Keys to move the cursor on the intent parameter, then he could change the parameter if needed. “OK” to validate the change, and “Exit” to invalidate the change.

Here please notice that “Z+/-” Keys are used to move the cursor but not to move Z axes when the cursor is on the layer on the main interface, that’s to say, if user want to move the Z axes, he would firstly push the “CL” key to let the cursor disappear.

8.3 Introduction to menus

Push the “Menu” key when the screen is on the main interface, it will show as below:



Figure:

Push “Y+/-“ keys to select the intent entry, then push “Enter” Key to check the sub menu.

8.3.1 Sys info

When the cursor is on “Sys info” entry, if “Enter” Key is pushed, the screen will show as below:

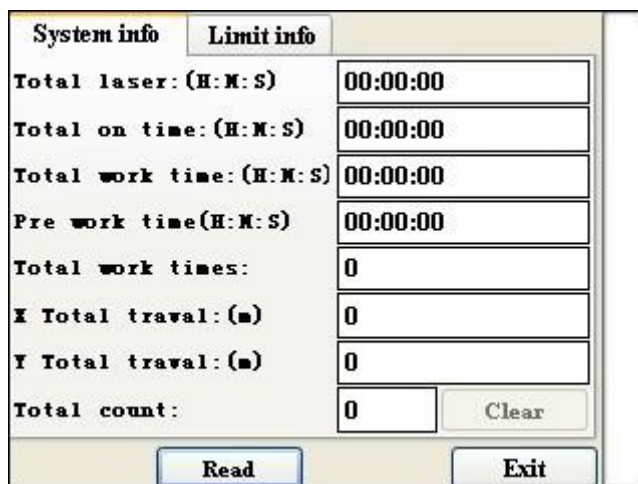

Figure:

The default cursor is on “Read” button, push “Enter” key to read all the system info. and the limit info.. “Z+/-“ keys could be used to move the cursor, and when the cursor is on “System info” label, “Y+/-“ keys could be used to change the label between “System info” and “Limit info”

8.3.2 Sys config

When the cursor is on “Sys config” entry, if “Enter” Key is pushed, the screen will show as below:

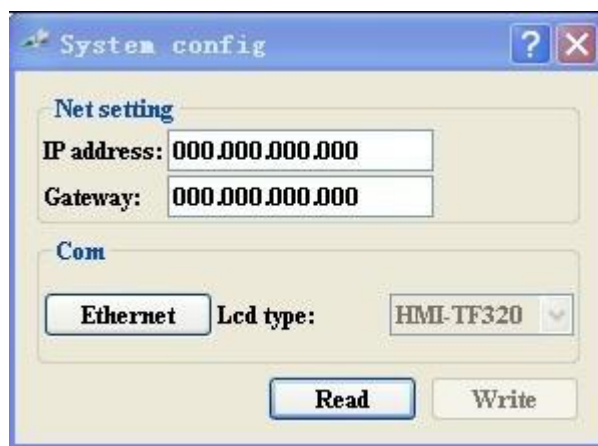

Figure:

The default cursor is on “Read” button, push “Enter” key to read the config information. “Z+/-“ keys could be used to move the cursor to select the intent label. If some value is changed, move the cursor to “Write” button and push “Enter” key, then the changed value could be saved.

“Lcd type” can’t be changed.

There are two options in “Com” label, “Ethernet” and “USB”. If users want to change this value, a password would be needed, show as below:



Figure:



Figure:

8.3.3 Function sub menu

When the cursor is on “Func” entry, if “Enter” Key is pushed, the screen will show as below:



Figure:

If the cursor is on “Origin X enable”, push “Enter” key to enable or disable the selected origin, if it’s enabled, the color frame would be red, otherwise it’s green.

- Multiple Origin Enable: “Yes” or “No” can be selected. If you select “No”, the system will use the single-origin logic. You can press the “Origin” key and set the origin, and only this origin can become valid. If you select “Yes”, the system will use the multiple- origin logic and the “Origin” key on the keyboard become invalid. In such a case,

the parameter of each origin must be set in the menu as follows.

- Origin X Enable: After the multiple-origin logic is enabled, the four origins can independently be prohibited and enabled.
- Set Origin 1/2/3/4: after the multiple- origin logic is enabled, you can stop the cursor at “Set as Origin 1/2/3/4”. Press the “Enter” key on the keyboard and the system will take the coordinate figures of current X/Y axes as the corresponding ones to the origin 1/2/3/4.
- Next Origin: there are such five digits as 0~4 for option, which are the origins to be used for the next figure. Origin 0 means the origin set by the “Origin” key on the panel in the single- origin logic. 1~4 means the serial number of the origins in the multiple-origin logic. Next origin can be modified to any one of origin 1~4, so as to control the start location of next work (the premise is that the origin is enabled), but it can’t be modified to origin 0.

 Prompt	Once the multiple- origin logic is selected and if the serial number of the next origin is 1 and four origins are enabled, when the memory file function is started or the processing file is uploaded into the PC and this file selects “Take the Original Origin as current Origin”, the work started for each time will use different origins. The rotation order of origin is 1->2->3->4->1->2.....
---	---

- Origin location: There are four entries to be selected: Top Left, Top Right, Bottom Left and Bottom Right. When one is selected, the previewed graph on the screen would be enantiomorphous based on X or Y direction.

 Caution	This item is only used to preview the file on the screen, and it is invalid to the machine’s movement.
--	--

- Set Para: After the “Set Para” is selected and the Enter key pressed, the interface will show the specific password to be entered when set as default parameter. After the manufacturer regulates all parameters of the machine well (including all manufacturer parameters and user parameters), this function can be used to store the well-regulated parameters to help users to recover the original parameters (including all manufacturer parameters and user parameters) through selecting “Recover Para” when they regulate parameters improperly.
- Recover Para: After the “Recover Para” is selected and the Enter key pressed, the “Successful Recovery” dialog box will pop up to prompt that all manufacturer parameters and user parameters are recovered successfully. You can return to the previous menu by press the Enter key.
- Auto Focus: When the cursor stops at “Auto Focus”, press the Enter key to search for the focus(When there is z axes, and the z axes reset function is enabled, the auto focusing is valid); press the Esc key to return the prior menu.

8.3.4 User para

When the cursor is on “User para” entry, if “Enter” Key is pushed, the screen will show as below:

Inci	Carve	Track	Reset	Other
Idle speed:	0.000			mm/s
Idle Acc:	0.000			mm/s ²
Start speed:	0.000			mm/s
Min Acc:	0.000			mm/s ²
Max Acc:	0.000			mm/s ²
Cutting mode:	Normal Cutting			▼
Acc mode:	S mode			▼
<input type="button" value="Read"/> <input type="button" value="Write"/> <input type="button" value="Exit"/>				

Figure:

The default cursor is on “Read” button, push “Enter” key to read all the user parameters. If some parameters are changed, then press “Write” button to save the new parameters. “Write” button can be pressed only after “Read” button is pressed.

8.3.5 Machine para

When the cursor is on “Machine para” entry, if “Enter” Key is pushed, the screen will show as below:

Laser	Enable	Axis	Other
Laser config:	One tube		▼
Laser mode:	Glass tube		▼
Max power 1:	0		W
Min power 1:	0		W
Laser freq 1:	0.000		Hz
Max power 2:	0		W
Min power 2:	0		W
Laser freq 2:	0.000		Hz
Laser atten:	0.0		W
<input type="button" value="Read"/> <input type="button" value="Write"/> <input type="button" value="Exit"/>			

Figure:

The default cursor is on “Read” button, push “Enter” key to read all the machine parameters. If some parameters are changed, then press “Write” button to save the new parameters. “Write” button can be pressed only after “Read” button is pressed.

8.4 Introduction to file function

8.4.1 Memory file

On the main interface, if “File” key is pressed, it will show as below:

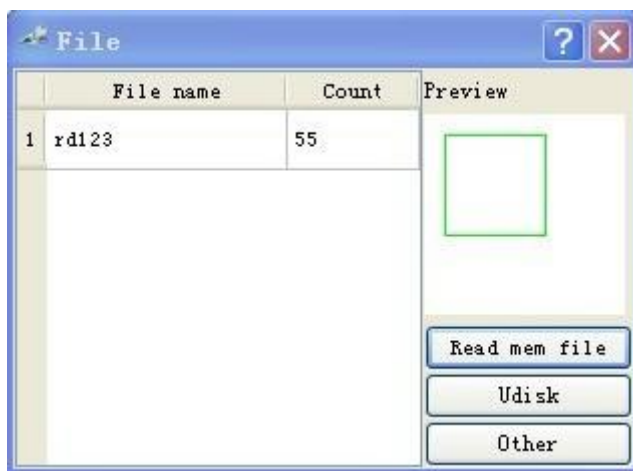

Figure:

When showing this menu, the system would read the memory file firstly, the file name and the running times would be listed in the left area, and the selected file is previewed in the top right area. “Y+/-“ keys could be used to move the cursor on the file name list. “Z+/-“ keys could be used to move the cursor on the button entry. When the cursor is on a target file name, presses the “Enter” key, the selected file will be previewed on the main interface.

If “Home” Key is pressed when the cursor is on a selected file name, the screen will show as below:



Figure:

Run: To run the selected file.

Track: To track the selected file, and the track mode is optional.

Work time: To forecast the running time of the selected file, and the time is accurate to 1ms.

Clear count: To clear the running times of the selected file.

Delete: To delete the selected file in the memory.

Copy to Udisk: To copy the selected file to Udisk.

If the “Other” entry in figure8.4-1 is pressed, the system will show as below:



Figure:

Cur work time: To forecast the running time of the current file(the current file No. is showed on the main interface), and the time is accurate to 1ms.

Clear all mem file count: To clear the running times of every file in the memory.

Del all mem file: To delete all memory files.

Format memory: To format memory, and all the files in memory will be deleted.

8.4.2 Udisk file

If the “Udisk” entry in figure8.4-1 is pressed, the system will show as figure 8.4-4, and the operation method is all the same as figure 8.4-1

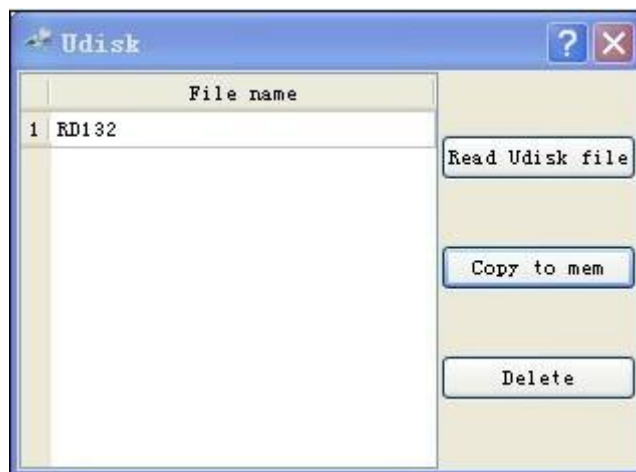



Figure:

 Prompt	This system supports such file formats of USB as FAT32 and FAT16, but it can identify them when the files are put under the root directory of USB. The file name of more than 8 characters will automatically be cut out by the system. The file name that has only English letters and digits will not show when they are copied to the mainboard. The files copied from the mainboard to USB will be placed under the root directory of USB.
---	--

8.5 Introduction to diagnoses function

If the “Diagnose” Key in the main interface is pressed, the system will show as below:

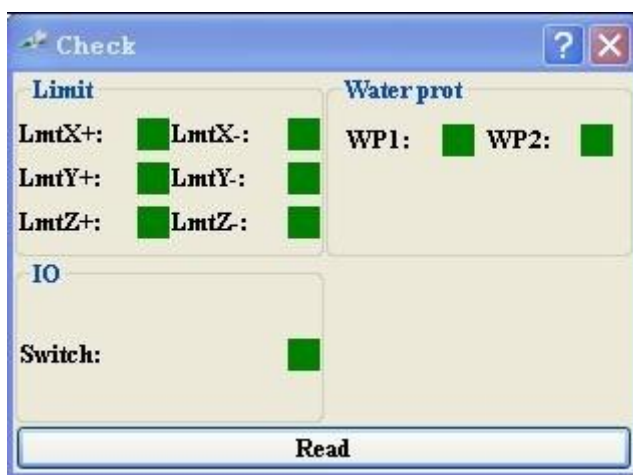

Figure:

This interface shows some system input information, such as limiter status, the status of the water protecting, and the status of the foot switch etc.. When the input is validated, the color frame will be red, otherwise it's green.

8.6 Introduction to some alarm info

When users are operating the system, or when the machine is running, some alarm information such as water protecting error maybe shows as below:



Figure:

Section 9 Manufacturer/ User Parameters Explanation

CONTENTS:

-  Manufacturer Parameters
-  User Parameters

9.1 Manufacturer Parameters

(1) axes' parameters

➤ **Direction Polarity:** Modification of direction polarity can move the motor to the opposite direction. The modification purpose can move this axle to the origin on resetting. If this axle moves far from the origin on resetting, it means the direction polarity of this axle is wrong in setting and should be modified.

➤ **Spacing Polarity:** it is used to set the high and low level mode of spacing signal. When the motion axle arrives at the spacing position and input a low-level signal to the mainboard, the spacing polarity at this time should be set to be minus.

➤ **Key Polarity:** it is used to control the movement direction of the axle that is moved through manual operation of the keys. After the direction polarity is correctly set, if you press the directional keys on the operating panel, this axle will move to the opposite direction. In such a case the polarity of keys should be modified.

➤ **Control Mode:** Double pulse or direction+single pulse are optional, in general, direction+single pulse is selected.

➤ **Hard-spacing Protection:** it is used for whether the hard-spacing protection of this axle is enabled.

➤ **Reset Enable:** if the machine is provided with this axle, its "Reset Enable" should be opened; if no, its "Reset Enable" should be prohibited.

➤ **Motor Stepping:** it means the impulse equivalent, the absolute distance gone by the corresponding motion axle when a pulse is delivered to the motor. Prior to the correct setting of this value, a large rectangle can be cut with the machine (the larger the figure is, the smaller the difference is). The motor stepping can automatically be calculated according to the figure length and measuring length.

➤ **Takeoff Speed:** it means the speed of the motion axle in direct start from the idle condition. If this value is excessively large, it will make the motor lose steps, jar and even squeak; if small, it will reduce the running speed of the whole figure. If the inertia of the motion axle is larger (the axle is heavier), you can set a smaller takeoff speed; if smaller (the axle is lighter), you can increase the takeoff speed. For example, the typical value is 5~30mm/s.

➤ **Maximum Speed:** it means the maximum limit of motion speed that this axle can bear. This parameter has something to do with the driving force of motor, the inertia of motion axle and its drive ratio. For example, the typical value is 200~500mm/s.

➤ **Acceleration:** it means the maximum acceleration of the motion axle in accelerated or decelerated motion. If the acceleration is set too large, it will make the motor lose steps, jar and even squeak; if too small, it will cause the reduction of acceleration so as to reduce the running speed of the whole figure. For the axles with larger inertia, such as Y axle corresponding to the beam, its typical setting range is 800~3000mm/s²; for the axles with smaller inertia, such as X axle corresponding to the car, its typical setting range is 8000~20000mm/s².

➤ **scope:** it means the farthest distance that the motion axle can move, which is determined in accordance with the actual condition of the machine.

- **Key Move Takeoff Speed:** it means the starting speed to move this axle by way of the keys on the keyboard, which can't be higher than the takeoff speed.
- **Key Move Acceleration:** it means the acceleration to move this axle by way of the keys on the keyboard, which can't be higher than the maximum acceleration of this axle.
- **Scram Acceleration:** if this axle enables the hard-spacing protection, when this axle moves to the spacing position, it will scam operation at the scam acceleration. This value can be 2~3 times of the maximum acceleration for this axle.
- **Distance from Origin to Hard Spacing:** if this axle enables hard-spacing protection, generally this value should be set to be 2~5mm; if it is set to be 0, when this motion axle moves to the smallest coordinate, i.e. 0, this spacing may be validate, which may wrongly triggers the hard-spacing protection and scam the machine. If the hard-spacing protection is not enabled, this value can be set to be 0~5mm.

(2) Laser parameters

- **Laser Configuration:** single laser and double lasers are available for option and set in accordance with the laser-tube quantity provided by the manufacturer.
- **Laser Type:** glass tube, RF laser (not need pre-ignition pulse) and RF laser (needing pre-ignition pulse) available for option.
- **Maximum Power 1**
- **Minimum Power 1**
- **Laser PWM Frequency 1**
- **Maximum Power 2**
- **Minimum Power 2**
- **Laser PWM Frequency 2**
- **Laser Attenuation Quotiety**

Laser PWM Frequency is used to set the pulse frequency of control signal used by this laser, in general, glass tube is about 20KHZ, RF laser is about 5KHZ ; the maximum/minimum power (%) is used to set the limit power of this laser, that is to say, during the operation, the maximum power set by the user can't be higher than that set here and the minimum power set by the user can't be less than that set here, either. When a laser's power is attenuated, then the laser attenuation quotiety may be set.

 Prompt	If it is only provided with the single laser, it can show the one-path parameter.
--	---

(3) Other Manufacturer Parameters

- **Machine Type:** In most cases, the general engraving machine should be selected and other types used for specific purposes.
- **Feeding Mode:** it has single-way mode and two-way mode for option. If it is of single-way feeding, it is unnecessary to check the coordinates. Feeding can be conducted in the single-way mode; if it is of two-way feeding, the system will check the maximum and minimum coordinates. The odd sequence means feeding should be done to one direction and the even sequence means feeding done to the other direction. The initial direction for the first time can be changed through setting the directional polarity or

modifying the plus and minus values of the feeding length. This parameter is valid only when the “Z axes function” is configured to “Drive for Feeding axes”.

➤ **Power-Off-Restart Delay:** it can be set to be 0~3000ms. After the power-off of the electricity grid, the power supply of the system will not drop to 0 at once. There is a delay during this time. The delay value set here should basically consistent with the actual off-delay value. If the deviation of set value is larger, on the de-energizing for continuous engraving, either the figure processed for the second time is not closed with that before the cutoff, or it is coincided with that too much.

➤ **Transmission Mode:** generally the “Belt Stepping Type” should be made choice of. The control algorithm will be changed a little when other types are selected.

➤ **Z Axes Function:** “Drive for flat” or “Drive for Feeding axes” are optional.

 Prompt	<p>After the configuration parameters in the manufacturer parameters, such as directional polarity, control mode, laser type and laser PWM frequency, are modified, the system should be reset. Such a modification can function upon the resetting of the system.</p>
--	--

(4) Enable Parameters

- **Laser 1 Enabled**
- **Laser 2 Enabled**
- **Water Protector 1 Enabled**
- **Water Protector 2 Enabled**
- **Door Opening Protection**
- **Whether to Enable the blower**

 Prompt	<p>The Enable Parameters are to enable or disable above functions. If the machine is provided with the parameter for the single laser in the manufacturer parameters, the display entry of enabling parameter will change accordingly.</p>
--	--

9.2 User Parameters

(1) Cutting Parameters (Only affect cutting arts)

➤ **Idle Move Speed:** this parameter decides the highest speed of all non-lighting lines for the machine in the movement process.

➤ **Idle Move Acceleration:** it means the highest acceleration of all non-lighting lines. Idle stroke speed and idle stroke acceleration can be set higher to reduce the working time of the whole figure, but if they are set too high, it may cause the jarring of track, so comprehensive consideration should be given to the setting.

➤ **Turning Speed:** it means the speed of turning at the acute-angle corner, which is also the highest speed in the whole cutting process.

- **Turning Acceleration:** it means the acceleration of turning at the acute-angle corner when cutting. If the two speeds are set too high, jarring will happen to the turning; if set too low, it will influence the cutting speed.
- **Cutting Acceleration:** it means the highest acceleration value in the whole cutting process.
- **Cutting Mode:** it is divided into high-speed cutting and precision cutting. In high-speed cutting, priority is given to the cutting speed, but in precision cutting, the cutting effect.
- **Acceleration Mode:** it is divided into T acceleration and S acceleration. T accelerate will quicken the whole cutting process, but it will result in that its cutting effect is inferior to that of S acceleration.

(2) Scanning Parameters (Only affect scanning arts)

- **X-axis Starting Speed**
- **Y-axis Starting Speed**
- **X-axis Acceleration**
- **Y-axis Acceleration**

The above four parameters are used to set the starting speed and acceleration of two axes on the scanning. The higher the two speeds are, the quicker the scanning is.

- **Scanning Line-feed Speed:** this parameter is specially used to control the highest speed at which that the previous line vertically moves to the next line in the scanning mode. If the space between lines is larger during the scanning or if the distance of each block is larger during the scanning and deblocking of figure, it is necessary to position each line or block accurately. In such a case the speed of scanning line-feed can be set as a lower value.
- **Scanning Mode:** it is divided into general mode and special mode for option. If special mode is used, the laser power should be increased. The smaller the speckle percentage is, the more the laser power reduces. The laser power to set should be larger in order to reach the same scanning depth. The purpose to select the special mode is to make the laser light at high power and short time. On the depth scanning the effect that the bottom is flatter is obtained, but it should be noticeable that if the speckle adjustment is not appropriate, it can achieve this goal. If the high power remains short, the lighting mode will influence the life of the laser. The system will default the selection of general mode.
- **Speckle Size:** When the general mode is selected as the scanning mode, this parameter will become ineffective; when the special mode is selected, this parameter will become effective. The controller will control this parameter among 50%~99%.

 Prompt	The cutting and scanning parameters can't exceed the limited ones in the axle parameters. If so, the setting will become ineffective and the system will automatically cover the parameters with the axle parameters.
---	---

(3) Reset Parameters

- **Reset Speed:** it means the speed of X/Y-axis linkage reset to the origin.

- **X-axis Startup Reset**
- **Y-axis Startup Reset**
- **Z-axis Startup Reset**
- **U-axis Startup Reset**

You can select “Yes” or “No” in the field of the above four parameters, which is used to confirm whether each axle can be reset on the startup.

(4) Frame Setting

- **Bordering Mode:** “Blanked Bordering” means idling to start border preview; “Outputted Border Cutting” can manually cut off the well-processed figure; “4-corner Dotting” means to emit the light at four corner points of the frame to make a point and turn off light. The size and position of this figure can be checked intuitively through the four points. The bordering speed is the speed value set on the keyboard when the system is idle. For light output, its minimum/maximum power is the corresponding value set on the keyboard when the system is idle (The lasering power on the 4-corner dotting means the well-set maximum power).

- **Margin Distance:** It means whether to extend a certain length outside the actual frame of the figure on the preview/cutting of frame.

 Prompt	<p>If the frame crosses the border, the interface will prompt it. If the Enter key is pressed at this time, the system will cut the border at the maximum/minimum coordinates first, and then border the figure. This bordering can be given up.</p>
---	--

(5) Other User Parameters

- **Array Mode:** Two-way array or one-way array can be selected. Two-way array means the to-and-fro cutting of array in sequence; one-way array means the cutting of array from one direction to another. On selecting one-way array, the elements of each array are the same in action mode and completely uniform in action fluency, which takes a little more time than two-way array. Two-way array is the default option.

- **Back Position:** The origin (the relative origin) and the machine’s absolute origin can be selected. This parameter decides the parking position of laser head after each work.

- **Before-feeding Time Lag:** settable at 0~300s. The lagged time can facilitate user’s feeding and picking on the feeding device.

- **After-feeding Time Lag:** settable at 0~9.9s. It can facilitate the feeding device’s delaying in jarring after moving to the correct position and waiting for the 2nd work after the feeding axle stands still completely.

- **Focus Setting:** it means the distance from the focal point of laser head lens to Z-axis origin. When there is no automatic focusing function, this parameter becomes invalid.

- **Backlash X:** The X axes’ backlash, accurate to 1μm.

- **Backlash Y:** The Y axes’ backlash, accurate to 1μm.

Thank you for your selection of our production!

All the copyright of this manual is owned by Ruida technology. Any person or company can not copy upload and send the manual without Ruida's permission.

Content will be revised or modified. We will not send message to every users.

If there are any question or suggestion about our products and manuals, please tells us.

Tel: (086)0755-26066687

Fax: (086)0755-26982287

Adress : 3th floor,Technology Building,NO.,1067 Nanhai Avenue,Nanshan district, Shenzhen, Guangdong , China.

Website: www.rd-ac.com